



Change the way you see the solar light

# SOLAR LED BATTEN LIGHTS



# Auroras Profile

Auroras is an innovative manufacturer accredited by ISO9001, ISO14001, ISO45001, and BSCI management and quality system etc. Auroras is dedicated and positioned to supply unique aesthetic, durable quality solar lights for the commercial market and high-end distribution markets. Since established in 2013, Auroras has been investing a lot of cost per year on new products development. Auroras is the pioneer in the solar lighting industry and leading the market trend in product design concepts and quality standards.



- In 2016, Auroras is the first company who released HELIOS all-in-two solar street lights in the world and successfully won the contract of UNHCR for 3 years.
- In 2017, Auroras is the first company that released all-in-one solar batten light in the world and defined what is solar led batten light in google search
- In 2018, Auroras released the THOR all-in-two solar street light who build in the biggest battery 2160WH in the world.
- In 2019, Based on future vision & forecast, , Auroras released the vertical solar street light system which is a the revolutionary design of solar lighting market.

In the same year, auroras won the contract from 43 competitors to supply vertical solar street light to 2019 Southeast Asian Games .

- In 2020, Auroras released the Athena solar pedestrian light which exceeded the quality and design expectations of customers for solar light. It gains lots of ultra-high praise.
- In 2021, Auroras won the project to supply solar lights to DUBAI EXPO 2020

## Quality Quality

Auroras is aware of the importance of the quality position since the first day when established. Different from the very regular products on market, All auroras' products are developed with a distinct aesthetic look and durable components with high specification performance. Quality is positioned on premium quality which is able to satisfy professional clients.

## Marketing Philosophy

Establishing strong & long-term relationships with clients as partners in the pursuit. Auroras is aimed to build a network of agents & distributors globally. Auroras has the strict principle whose purpose is to protect customers' rights and benefits. It takes a long time and lots of effort to promote new products to market which is performed on the basis of customers' trust in Auroras.



مجلس أبوظبي للجودة والمطابقة  
ABU DHABI QUALITY AND CONFORMITY COUNCIL



## Products Certificates

Auroras Innotech is certified by ISO9001, ISO14001, ISO45001 and accredited by BSCI. Products are certified by CE, ROHS, CB, IECEE, LM79, LM80, TM21 , and IK tests etc. Auroras products obtain most of the certificates to meet the demand of high-end projects.

## ADQCC Approval

Abu Dhabi Quality and Conformity Council has launched the Trustmark (AbuDhabi Trustmark) which indicates product's compliance with safety, environmental and performance standards, in addition to administrative and production systems compliance with the conformity Program. In 2022 April, Auroras's products are finally approved by ADQCC and authorized with AD mark.

Auroras  
Products+



# APOLLO

---

## SOLAR BATTEN LIGHT

APOLLO solar batten light is a good choice for vast solar lighting applications. LifePO4 battery and high charging efficiency solar controller are built inside of the light. Ultra-high brightness led is used, it reaches high lumens output up to 160lm/watt. IP65 weatherproof lighting fixture with the PC fixture, The easy MC4 plug-in setup makes the light extremely easy for installation and portability. Distance from solar panel to light is up to 30 meters

Solar batten lights are capable of meeting many applications and challenging solar lighting requirements with extremely simple and easy installation capability. It is a perfect solution for many outdoor applications such as carports, bus shelters, warehouses, temporary shelters, outdoor kiosks, street kiosks, camping tents, Boats or any remote locations where the grid is a challenge.





## FEATURES



### IP65 Weather Proof

Designed for outdoor application. Good to used any places like shelters, bus stations, warehouse etc.



### Motion Detection

Built in motion sensor function to save more energy for the area where there is weak solar radiation.



### Automatic ON/OFF

Light is working automatically ON/OFF from dusk to dawn, no need for manual operation, working time can



### Designing Concept

Athena solar garden light is designed with an aesthetic appearance, simple slim curvy with modern look.



### Quality Positioning

Especially designed for high-end customers with stable quality, smooth and high brightness performance.



### Easy Installation

Apollo adopts very neat and compact design, customer only need to plug solar light to solar panel by

# Specification

Model Name	AI-X2200	AI-X4800
LED source	18W SMD5730	36W SMD5730
Luminous flux	2,200lm max	4,800lm max
Color temperature	3000K / 4000K / 6000K	3000K / 4000K / 6000K
Dimension	92*84*600mm	92*84*900mm
Solar panel	50W 18V	80W 18V
Lithium battery	12.8V 12AH 154WH	12.8V 24AH 307WH
Solar charge controller	PWM	PWM
Charge & discharge time	5 hours / 24 hours	
Working temp.	-20 °C ~ 60 °C	
Motion sensor	Microwave sensor	
IP & IK Raterate	IP67 IK10	
Housing materials	Aluminium alloy + polycarbonate	
Cable length	5 meters / customzied	
Warranty	3 years	
Certificates	CE ROHS IP65	

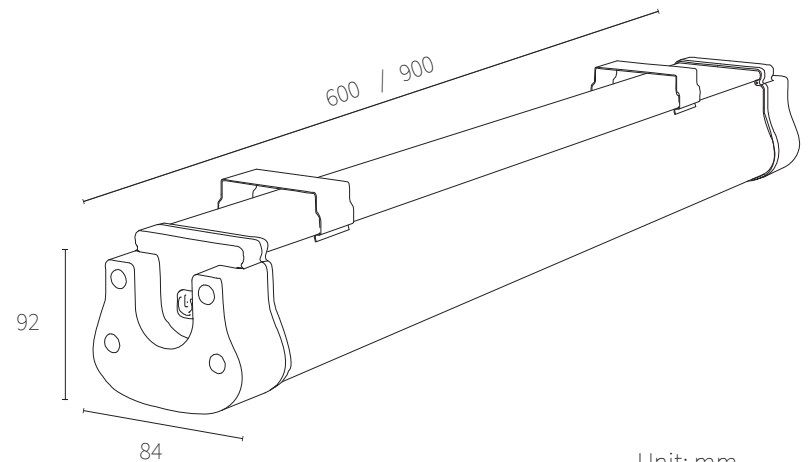
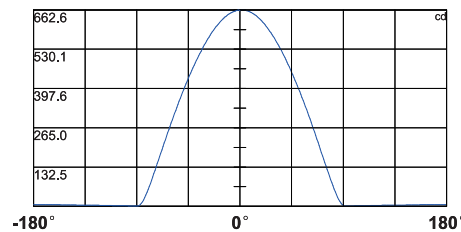
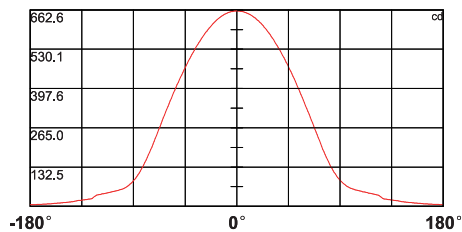
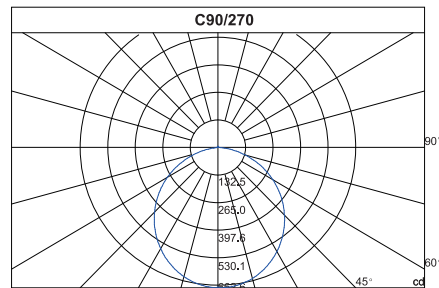
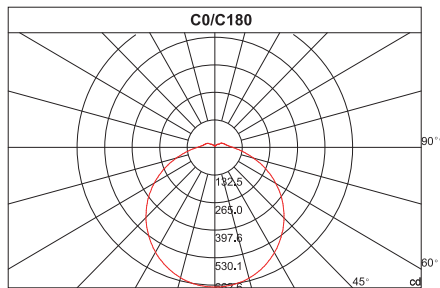

Unit: mm

## Installation Reference

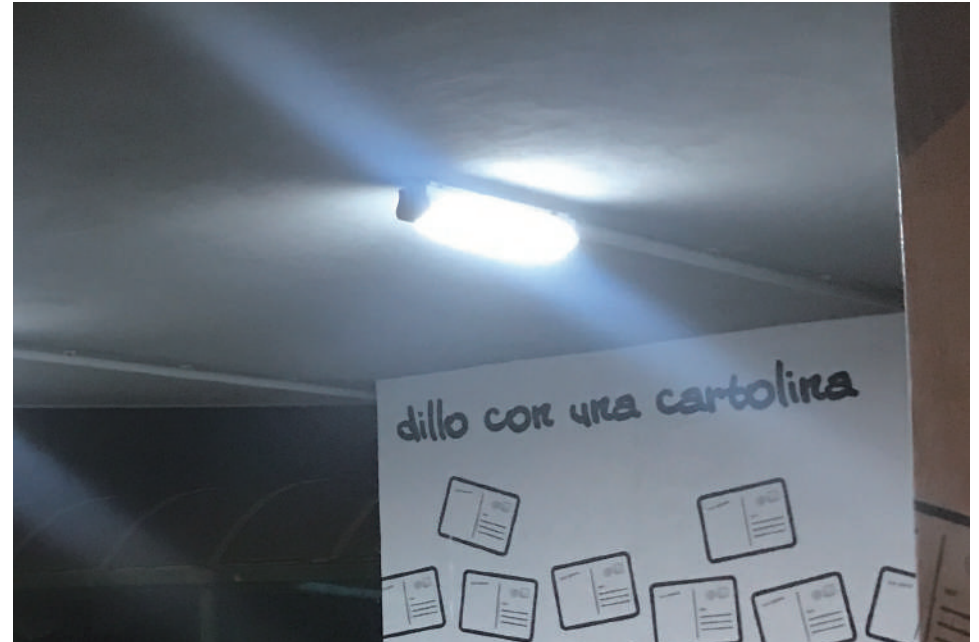

# SOLMATE

## SOLAR BATTEN LIGHT KIT

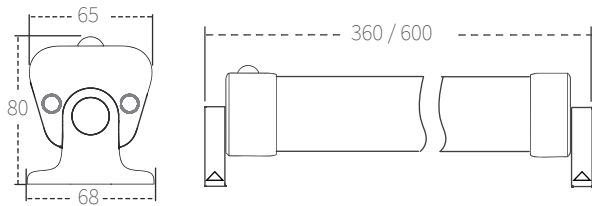

SOLMATE Solar LED batten light is specially designed for retail & distribution market. Can be widely used in many applications, such as office, home, garage, caravan, carports, bus stations, warehouses, camping tents, farm tents, sidewalks & alleyways, emergency camps, aid tents, caves, or many kinds of temporary or permanent accommodation structures, etc. Solar LED batten light is a kit that contains everything - rechargeable lithium battery, solar controller, and solar panel. Easy installation in less than 5 minutes; It provides a high brightness level over a long period of time, continuous lighting output, and built-in PIR sensor to save power if sunshine is not strong enough.

This solar LED batten light also supports working during day time while being charged- under manual operation. By programming the remote control, you can increase or decrease the brightness as you wish; there are 2, 4 and 6 hour settings available. One 5V USB output is included to charge a mobile phone. It is a perfect lighting solution for remote areas, that lack either power or fixed lighting.

# Key Feature



Extension to Wall Switch  
Light can be ON/OFF like a regular light by wall mounted switch, easy to use



Long light work  
Up to 12 hours working.  
Continuous lighting output.



USB Output  
Backup to charge mobile, useful in emergency.



IP65 Waterproof  
Can be widely used in outdoors, never worry water leaks in.



PIR Sensor  
Motion sensor function is available to save more energy

## Wall Switch



With this extension wall switch, the light can be ON/OFF easily as needed like traditional 220V light. It is functional both for day time or night,

It is an ideal answer to offer lighting service to the remote areas where there is no electricity or space where there is no light even

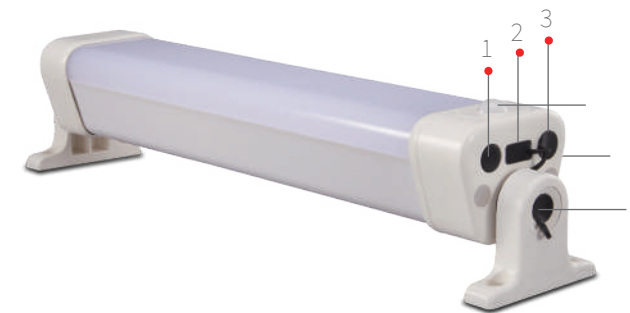

- 1 : Push Switch
- 2 : USB Output
- 3 : Connector to external switch

- 4 : Motion (PIR) Sensor
- 5 : Solar Panel Input
- 6 : Adjustable Light Brackets

# Specification

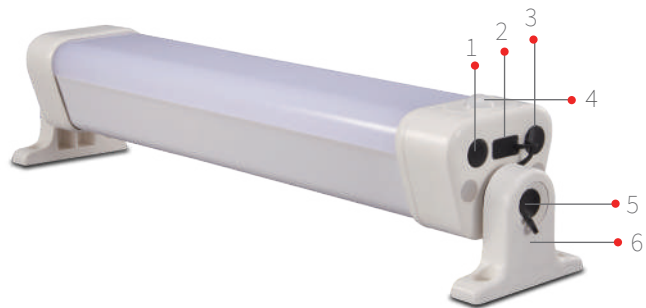

- 1 : Push Switch
- 2 : USB Output
- 3 : Connector to external switch
- 4 : Motion (PIR) Sensor
- 5 : Solar Panel Input
- 6 : Adjustable Light Brackets

# Installation & Marketing



Model name	E360	E600
LED peak power	12W	24W
Luminous flux	1,500lm max	2,400lm max
Color temperature	3000K / 4000k / 6000K	3000K / 4000K / 6000K
Dimension	360*65*80mm	600*65*80mm
Solar panel	10W 6V mono	18W 6V mono
Lithium battery	3.7V 8.8AH	3.7V 17.6AH
Housing material	Polycarbonate + aluminium	
Charge & discharge time	5 hours / 24 hours	
Working temp.	-20 °C ~60 °C	
Motion sensor	PIR sensor	
USB output	5V 1A max	
IP rate	IP65	
Cable length	5 meters / customzied	
Warranty	2 years	
Certificates	CE ROHS	



EXPO  
2020  
DUBAI  
UAE

# SolarWrap

VERTICAL SOLAR POLE

Showcasing real solutions to the world's biggest challenges.

Designed by Mr.Auroras, the vertical solar lighting pole is a great innovation for outdoor lighting. It is a revolutionary design with an aesthetic appearance and high stability of lighting performance. The concept of vertical solar lighting pole is delivered to every corner of the world globally with the impact of Expo Dubai.







## Auroras Innotech (GuangDong) Co., Ltd

 Website :  
[www.auroraslighting.com](http://www.auroraslighting.com)

 Email :  
[Sales06@auroraslighting.com](mailto:Sales06@auroraslighting.com)

 WhatsApp :  
+86 185 0756 4132

 Telephone :  
+86 0756-8530887 / 8530371  
0760-86687850 / 86687851

 Head office : 2/F 617# HuaYu Road, XiangZhou District, Zhuhai, GuangDong, China 519000  
Sub-factory : 2/F, B# Bldg,1# Dongcheng road, SanXiang GuangDong CHINA 528463  
Dubai office : Al quoz industrial area 4 , 318th road P.O. Box: 118023,Dubai, U.A.E  
Saudi Arabia office : Riyadh, Kingdom of Saudi Arabia

